

Composite dry sliding bushings, metric dimensions

Principal dimensions			Basic load ratings		Mass	Designation
d	D	B	dynamic C	static C0		
mm			kN		kg	-
<b>40</b>	44	20	61	193	0,039	PCM 404420 E

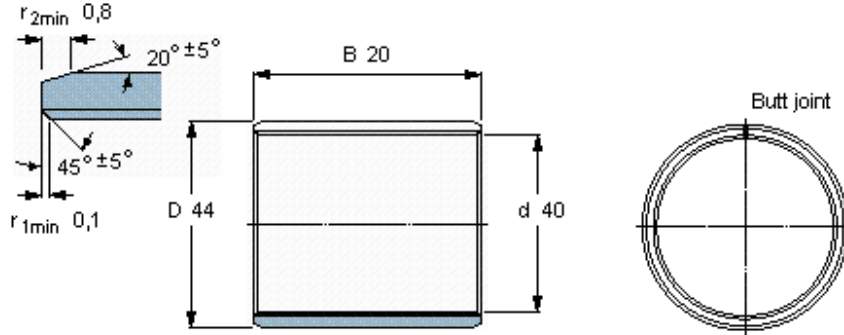

**Specific load factor**  
**Material constant**

K 80  
K<sub>M</sub> 480